

B48 CBRS 3.6GHz Bandpass BAW Filter

AKF-1336

Description

Akoustis' AKF-1336 is a high performance, ultra-small bandpass BAW Filter targeting 5G B48 Citizen Broadcast Radio Solutions (CBRS) infrastructure applications. AKF-1336 utilizes Akoustis' XBAW technology which provides leading RF filter performance. This BAW filter provides 150 MHz bandwidth, low insertion loss at 3.6 GHz and high out of band attenuation. AKF-1336 uses standard hermetic sealed ceramic packaging and is compatible with high volume, lead-free SMT soldering processes.

Features

- Ultra small form factor 2.5mm x 2.0mm x 0.8mm
- Single ended 50 Ohm Ant, Tx/Rx ports
- High out of band attenuation
- High power handling, maximum +30dBm
- Low insertion loss 150 MHz passband filter
- Performance -40 C to +85C
- RoHS Compliant

Applications

- 5G Infrastructure
- B48 CBRS
- General Purpose Wireless

Functional Block Diagram

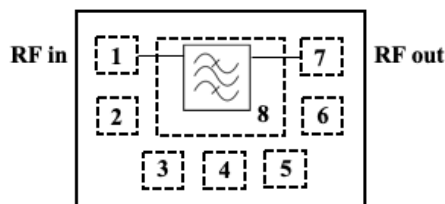

Pin #	Description
1	RF Input
2	Ground
3	Ground
4	Ground
5	Ground
6	Ground
7	RF Output
8	Ground

Ordering Information

Part Number	Description
AKF-1336EVB	Evaluation board
AKF-1336SP	(5) Loose pcs
AKF-1336SR	(100) Short Reel
AKF-1336TR1	(1000) Tape & Reel
AKF-1336TR2	(2500) Tape & Reel

Absolute Maximum Rating

Parameter	Rating
Storage Temperature	-40 to 125 °C
Input Power (CW)	+32 dBm

Nominal Operating Parameters

Parameter	Units	Min.	Typ.	Max.
Center Frequency (Fc)	MHz		3625	
Pass bandwidth	MHz		3550 – 3700	
Insertion Loss				
3550 – 3700 MHz	dB		1.5 ¹	TBD
Amplitude Variation				
3550 – 3700 MHz	dB		1	TBD
Attenuation				
10 – 1000 MHz	dB	TBD	50	
1700 - 2690 MHz	dB	TBD	25	
2690 - 3450 MHz	dB	TBD	25	
3450 - 3530 MHz	dB	TBD	15	
3720 – 3800 MHz	dB	TBD	15	
3800 - 6000 MHz	dB	TBD	25	
6000 - 8000 MHz	dB	TBD	18	
Return Loss				
3550 - 3700MHz			16 ¹	
Operating Temperature	C	-40		85
Load Impedence	Ohm		50	
Power Handling	dBm			30

Note:

1. S-parameter averaged over specified pass band frequency at room

Schematic & Bill of Materials

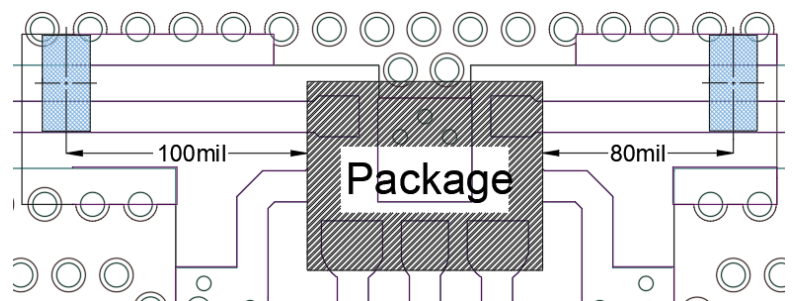
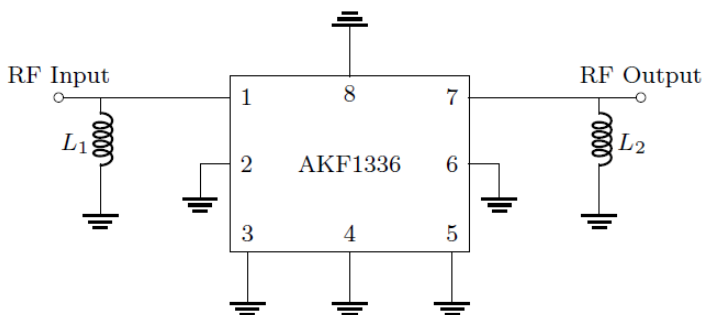

Reference Des.	Value	Description	Manufacturer	Part Number
PCB	N/A	2 layer	Multiple	
U1	N/A	3.6 GHz BAW Filter	Akoustis	AKF-1336
L1	2.8nH	Chip inductor, 0402, ± 0.1 nH	Murata	LQW15AN2N8G8ZD
L2	3.4nH	Chip inductor, 0402, ± 0.1 nH	Murata	LWQ15AN3N4C10D

Performance Plots

Passband Insertion Loss

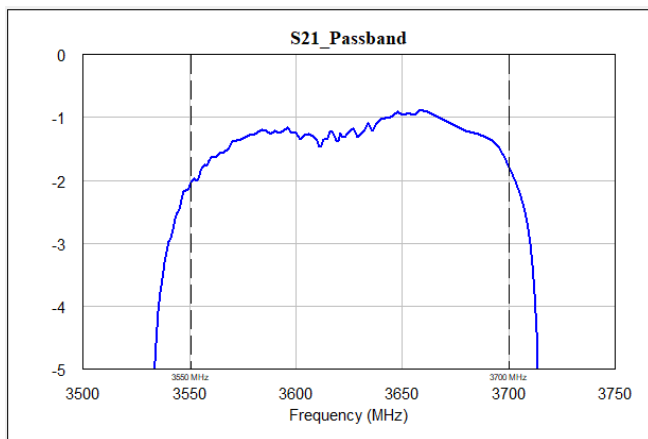

Return Loss

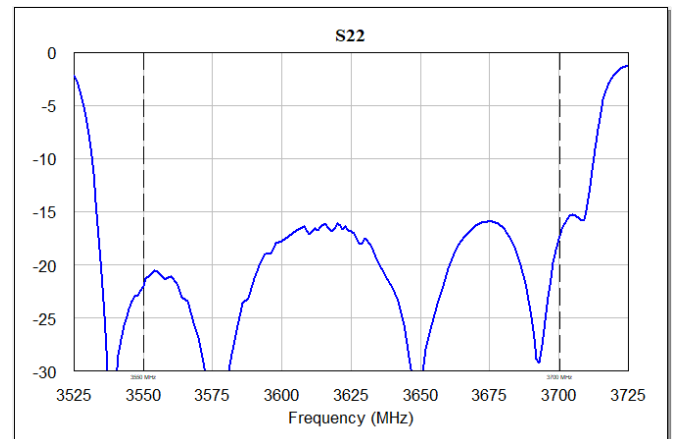

Narrowband Response

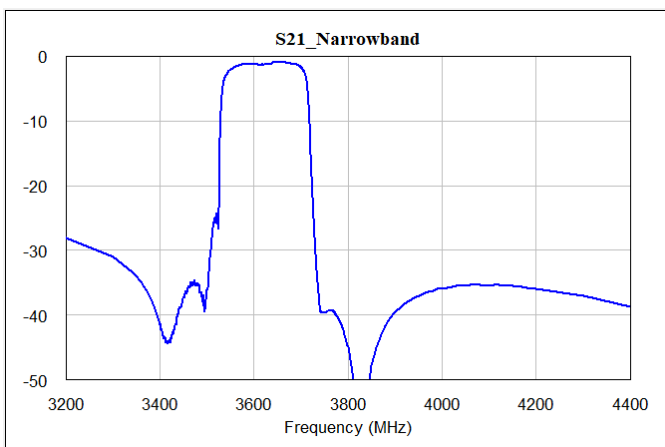

Wideband Response

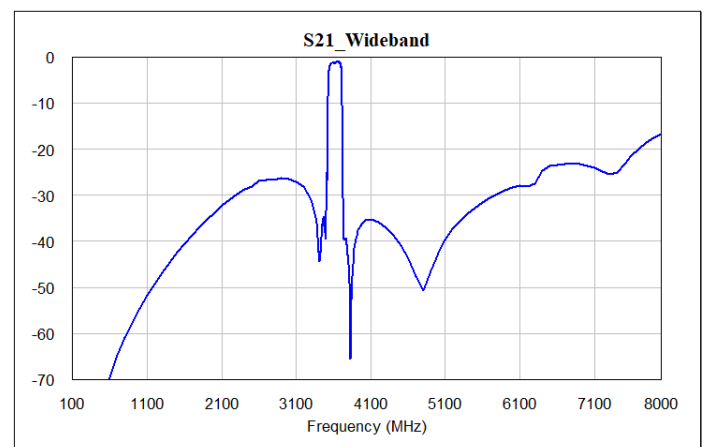

S11 Smith Chart

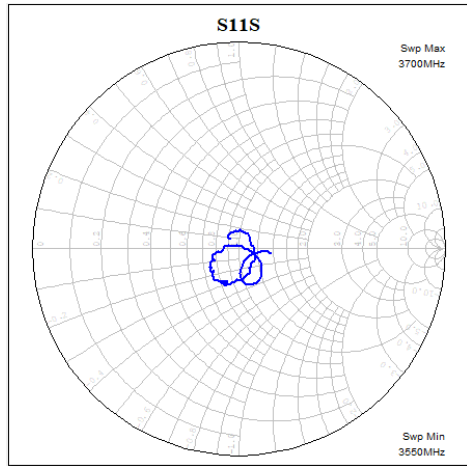

S22 Smith Chart

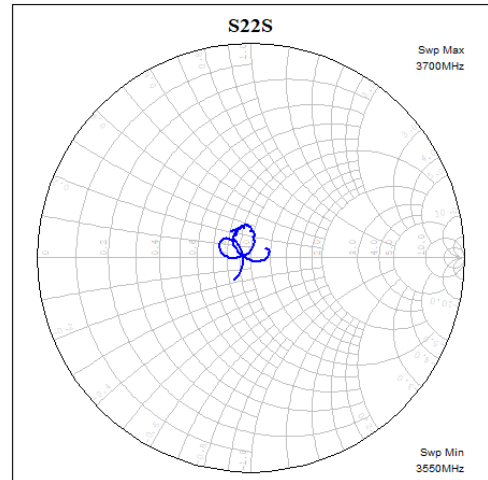

Package Dimensions & Pin Descriptions

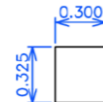
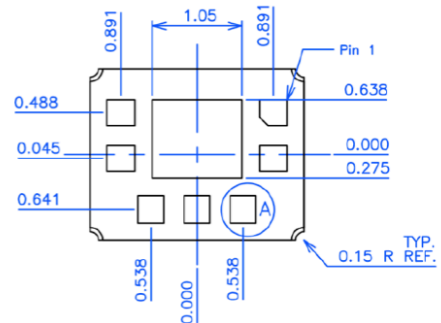
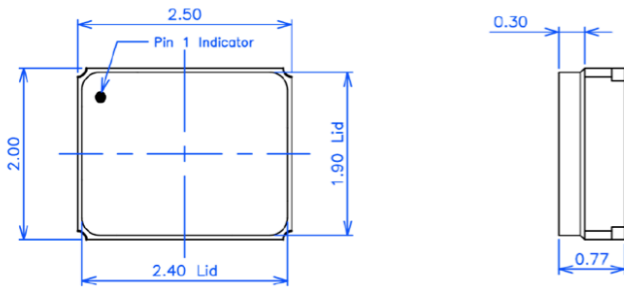

DETAIL A
PAD
SCALE: 2x
3X THIS ROTATION
4X ROTATED 90°
PIN 1 CHAMFER 0.150 X 45°

NOTES:

- PLATING THICKNESS
ELECTRO Ni : 1.27~8.89µm(S/P)
ELECTRO Au : 0.30~1.00µm(S/P)

Notes:

- All Units are in mm unless otherwise stated
- General Tolerance:
Linear X.XXX = ±0.050mm
X.XX = ±0.10mm

PCB Mounting Pattern

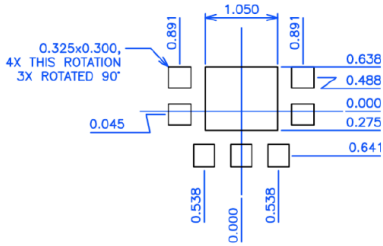

Recommended PCB Metal Top View

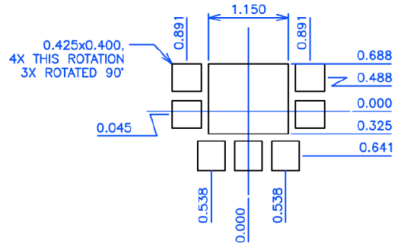

Recommended Solder Mask Opening Top View

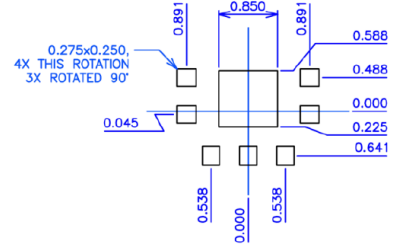

Recommended Stencil Pattern Top View

Typical Part Marking

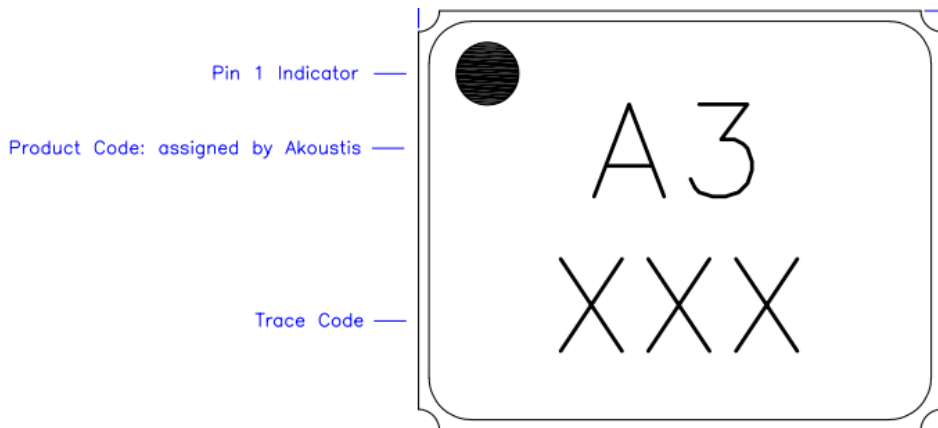

Reel Dimension

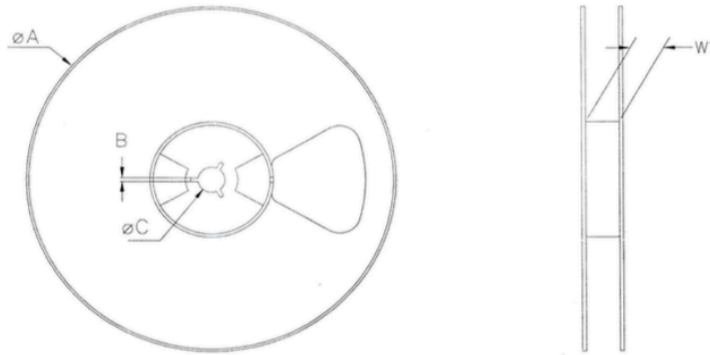

Item	Parameters	Method	Min	Max
1	ϕA (180mm + 0 / - 2.0)	Caliper	178.96	179.00
2	B (1.5mm Min)	Caliper	2.33	2.36
3	ϕC (13.0mm + 0.5 / - 0.2)	Caliper	13.26	13.29
4	W1 (8.40mm + 1.5 / - 0)	Caliper	9.24	9.27
5	Surface Resistivity (10 ¹¹ Max) ohms / sq	S.R meter	10 ⁹	10 ¹⁰
6	Visual		PASS	

Tape Dimension

A₀ = 2.25
 B₀ = 2.70
 K₀ = 1.20

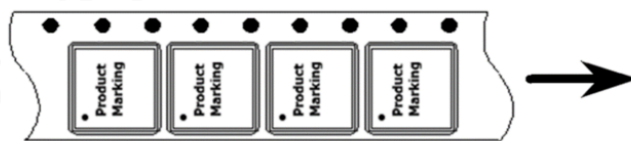
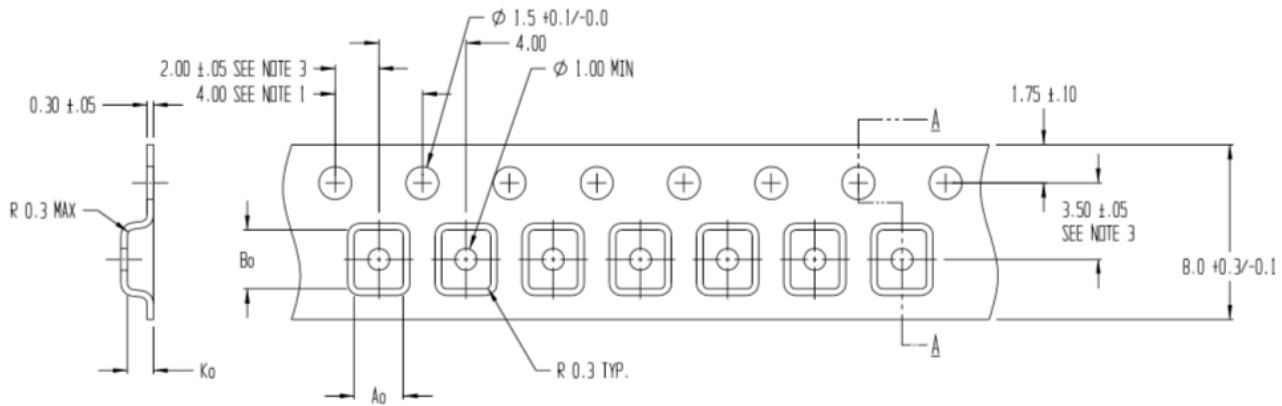

Recommended Solder Profile

Parameter	Eutectic Sn/Pb	Pb Free
Max Ramp Up Rate	6 Deg C/Second	6 Deg C/Second
Soak Temp Time $T_{S(min)}$ - $T_{S(max)}$	135 - 155 Deg C	150-200 Deg C
Max Soak Time T_S	2 minutes	3 minutes
Liquidous Temp T_L	183 Deg C	220 Deg C
Max Time Above T_L	150 Seconds	150 Seconds
Max Peak Temperature T_P	225 Deg C	260 Deg C
Max Time at Peak T_P	30 Seconds	30 Seconds
Max Ramp Down Rate	10 Deg C/Second	10 Deg C/Second

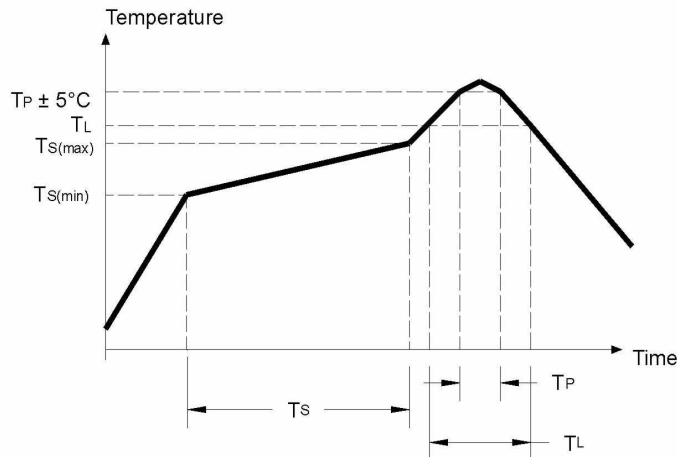

Product Compliance Information

ESD Sensitivity Ratings

Human Body Model (HBM) Test

Rating: TBD

Standard: ANSI/ESDA/JEDEC JS-001-2017

Charged Device Model (CDM)

Rating: TBD

Standard: ANSI/ESDA/JEDEC JS-002-2014

MSL Rating

N/A – Hermetic Package

RoHS

This part is compliant with 2011/65EU RoHS directive on the restrictions of the use of certain hazardous substances in electrical and electronics equipment as amended by Directive (EU) 2015/863

Contact Information

All contents specified in datasheet are subject to change. Please contact Akoustis for the latest on our products and company information.

Email: sales@akoustis.com

Website: www.akoustis.com

Telephone: +1 704.997.5735

Fax: +1 704.997.5734